

Gunite Automatic Slack Adjuster

Installation and Service Manual



Assembled in the USA



Your only single source for industry-leading wheel end solutions.
STEEL & ALUMINUM WHEELS | DRUMS | HUBS | ROTORS | SLACK ADJUSTERS

TABLE OF CONTENTS

INTRODUCTION

| | |
|---|----|
| Overview | 4 |
| Clevis Descriptions | 5 |
| ASA Installation Preparation | 5 |
| ASA Installation Procedures by Clevis | 6 |
| Collar Lock Clevis | 6 |
| Threaded Clevis | 8 |
| Welded Clevis | 10 |
| Brake Adjustment | 11 |
| Power Stroke Inspection | 11 |
| Recommended Maintenance | 12 |
| Bushing Replacement | 13 |
| Cutting Push Rods | 13 |
| Brake Lining and/or Drum Replacement | 14 |
| Trouble Shooting | 15 |

WARNING

AS WITH ALL PRODUCTS, CLOSE ATTENTION SHOULD BE GIVEN TO ALL INSTRUCTIONS INCORPORATED IN THIS MANUAL, IN PARTICULAR THE NOTES AND WARNINGS WHICH ARE HIGHLIGHTED. THIS MANUAL IS FOR GUNITE AUTOMATIC SLACK ADJUSTERS ONLY.

FAILURE TO STRICTLY FOLLOW THESE INSTRUCTIONS MAY RESULT IN THE UNIT PERFORMING IN AN UNSATISFACTORY MANNER AND RESULT IN INADEQUATE BRAKING ABILITY OR DRAGGING BRAKES. THESE CONDITIONS COULD MAKE OPERATION OF THE VEHICLE EXTREMELY HAZARDOUS.

ATTENTION

WHEN INSTALLING OR REPLACING A GUNITE AUTOMATIC SLACK ADJUSTER, A NEW CLEVIS MUST BE INSTALLED. REFER TO GUNITE PARTS CATALOG GUN1.0004 AND/OR ITS ADDENDUM FOR CLEVIS SELECTION.

WARNING

GUNITE AUTOMATIC SLACK ADJUSTERS SHOULD NOT BE MANUALLY ADJUSTED IN AN EFFORT TO CORRECT EXCESSIVE PUSH ROD STROKE. EXCESSIVE PUSHROD STROKE INDICATES THAT A PROBLEM EXISTS WITH THE GUNITE AUTOMATIC SLACK ADJUSTER, WITH THE INSTALLATION OF THE AUTOMATIC SLACK ADJUSTER, OR WITH THE RELATED FOUNDATION BRAKE COMPONENTS, WHICH MANUAL ADJUSTMENT WILL NOT FIX. MANUAL ADJUSTMENT OF GUNITE AUTOMATIC SLACK ADJUSTERS IS A DANGEROUS PRACTICE THAT COULD HAVE SERIOUS CONSEQUENCES, BECAUSE IT GIVES THE OPERATOR A FALSE SENSE OF SECURITY ABOUT THE EFFECTIVENESS OF BRAKES WHICH ARE LIKELY TO GO OUT OF ADJUSTMENT AGAIN SOON.

Overview

Gunite offers a complete line of unhandred automatic slack adjusters for installation on steer, drive, and trailer axles. The space required for the Gunite automatic slack adjuster is similar to that which is required for manual slack adjusters. Gunite automatic slack adjusters do not require any external brackets, adapters, or special mounting holes for installation.

Popular spline and arm length combinations allow them to be used to replace most other slack adjusters. However, brands should not be mixed on the same axle.

THE BRAKES SHOULD BE IN GOOD OPERATING CONDITION AND STATE OF REPAIR WHEN GUNITE AUTOMATIC SLACK ADJUSTERS ARE INSTALLED. NO SLACK ADJUSTER CAN COMPENSATE FOR PROBLEMS AND DEFICIENCIES IN THE FOUNDATION BRAKING SYSTEM.

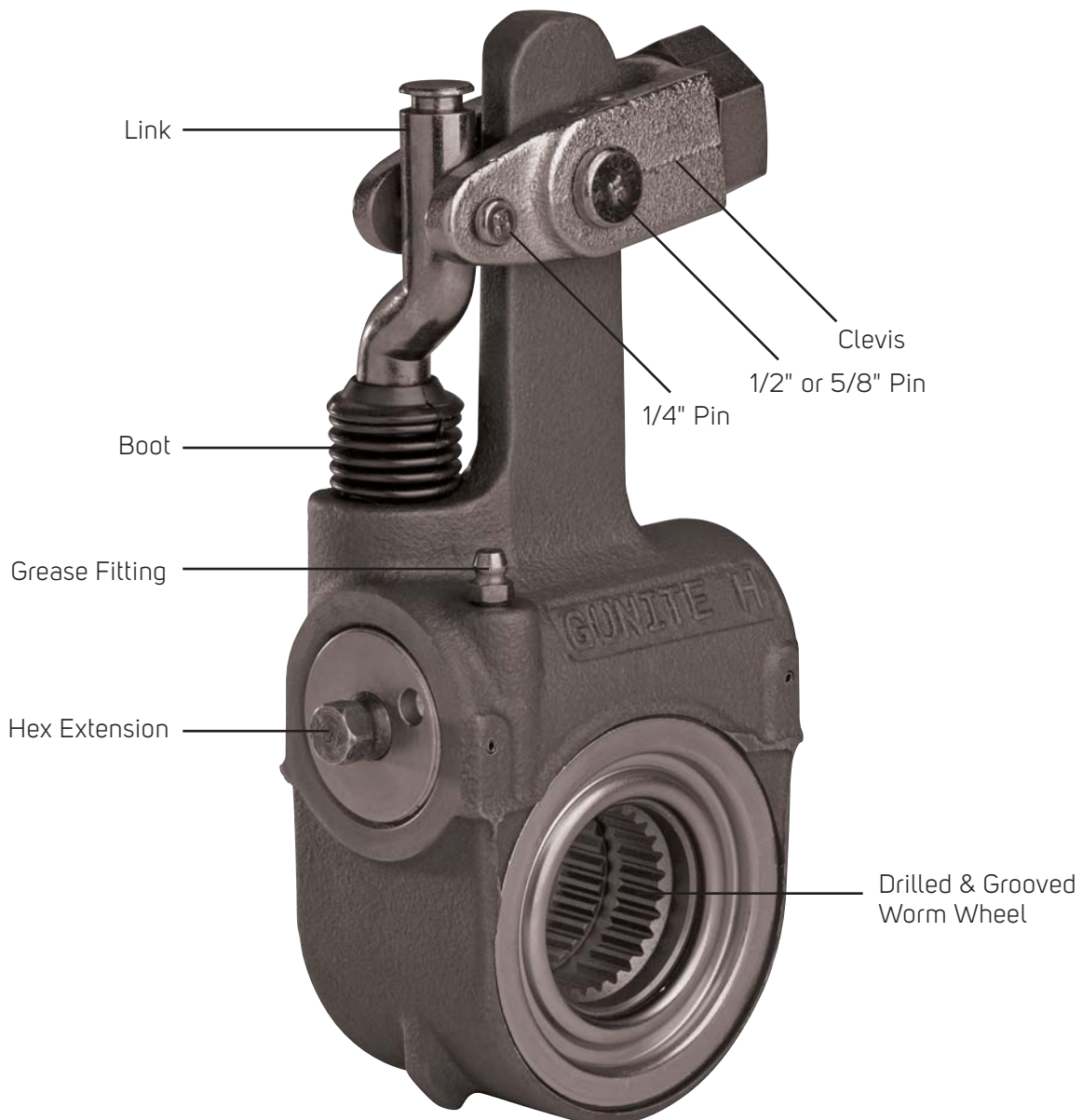
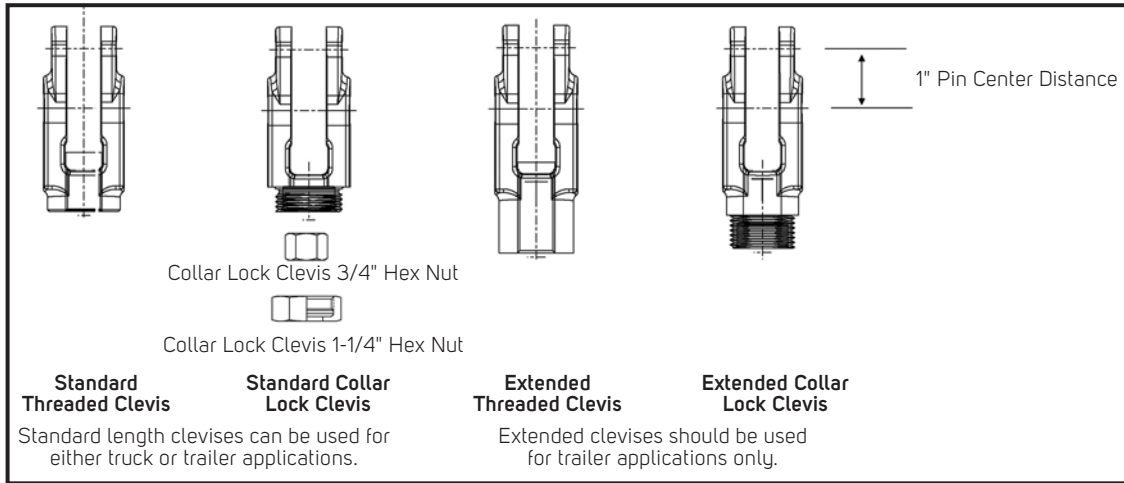

Figure 1 – Gunite Automatic Slack Adjuster

Clevis Descriptions

1" Pin Center Distance Clevises (Use with Traditional 1" Pin Distance ASA, Installation Gauge SD04603)



1.3" Pin Center Distance Clevises (Use with Gunite 2000 ASA, Installation Gauge SD04604)

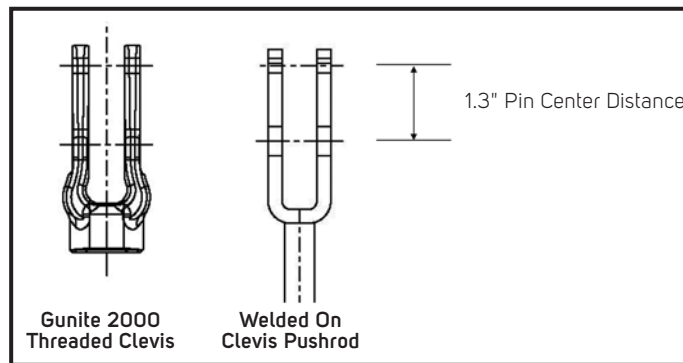
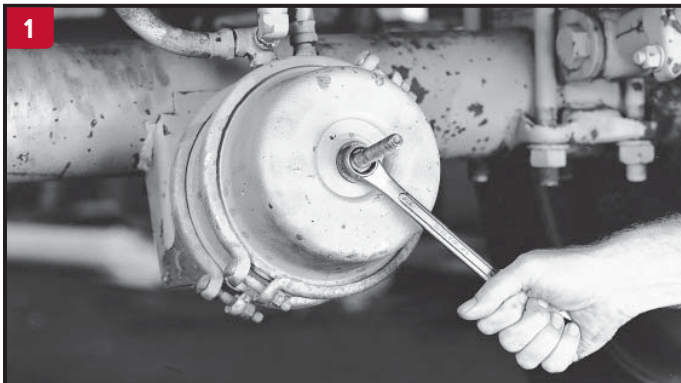

Figure 2 – Clevis Types

ASA Installation Preparation



1 Block the vehicle's wheels. If the axle is equipped with spring brakes, manually cage the brakes following the manufacturer's recommended procedures.

Check the operating condition of the foundation brakes, including drums, shoe and lining, cams, bushings, rollers, etc. Replace or repair as necessary.

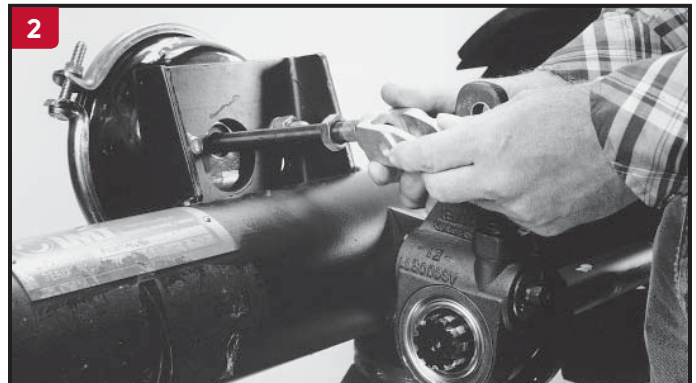

2 Remove the existing clevis and Gunite automatic slack adjuster. Keep the existing mounting hardware. Do not remove the clevis jam nut.

Refer to Figure 2 and determine if your Gunite automatic slack adjusters are equipped with the threaded clevis, welded clevis, or the collar lock clevis (extended or standard length). Refer to the correct installation procedure for the style of clevis used on your Gunite automatic slack adjusters.

ASA Installation Procedures by Clevis

Collar Lock Clevis ASA Installation Procedure

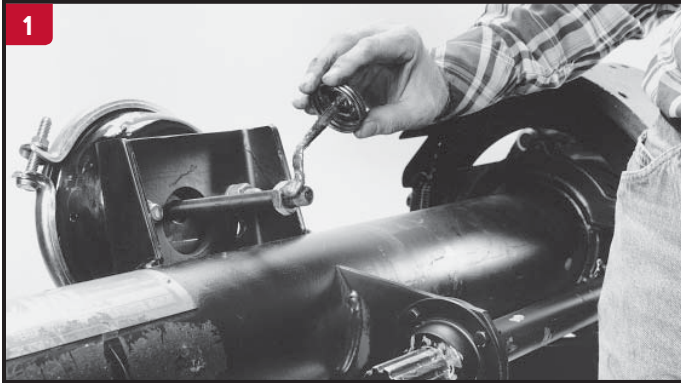

Apply anti-seize to the chamber push rod threads before installing the new clevis. Also apply anti-seize to the camshaft at this time.

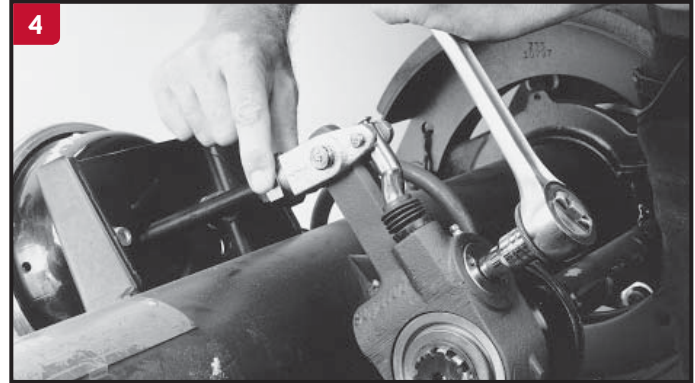

Using the hex extension and a wrench, adjust the Gunite automatic slack adjuster so that the collar nut aligns with the threaded area of the clevis. **Do not use an air impact wrench on the 7/16" hex. It can damage the clutch.**

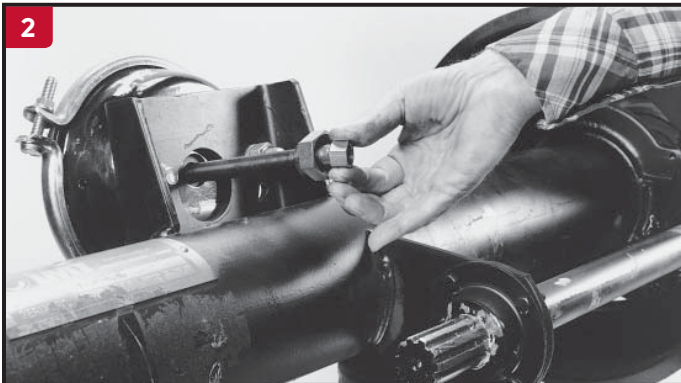

When installing a Gunite automatic slack adjuster with a collar lock clevis, place the 1-1/4" collar nut on the push rod against the 15/16" jam nut. Next thread the 3/4" hex nut onto the push rod.



Before attaching the 1-1/4" collar nut to the clevis, check to make sure the threaded push rod is fully engaged in the 3/4" hex nut. If the push rod does not have full engagement, a new push rod must be installed and cut to length. Refer to the section on cutting a new push rod to length in this service manual.

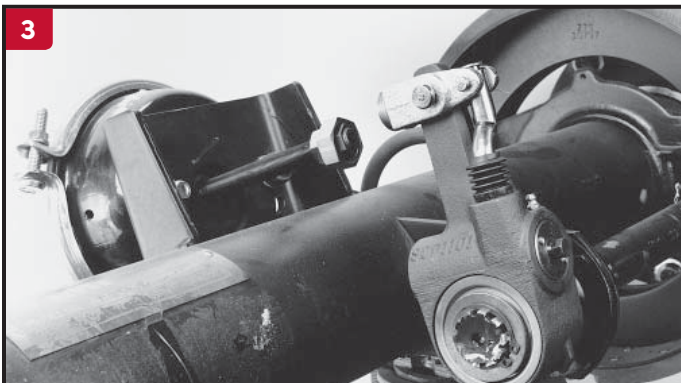

Install the slack onto the camshaft using the original mounting hardware.

The push rod may extend up to 1/16" past the clevis opening. If the push rod extends more than 1/16" past the clevis opening, mark the push rod and remove the clevis to allow the push rod to be cut to the proper length.

Gunite automatic slack adjusters using the collar lock clevis are available with either standard or extended clevis designs depending on the application. On trailer applications, an extended clevis can be used instead of replacing the push rod. However, you must still have full thread engagement inside the hex nut. If you have less than full thread engagement, a new push rod must be installed. If you replace the push rod, you must cut the new push rod to the proper length. Refer to the section on cutting a new push rod to length in this service manual. **Do not use an extended clevis on tractor applications, the extended clevis may interfere with the face of the air chamber.**

NOTE

On axles equipped with spring brake chambers, be sure the chambers are fully caged before cutting the push rod. If the spring brakes are not fully caged, the push rod can be cut too short.

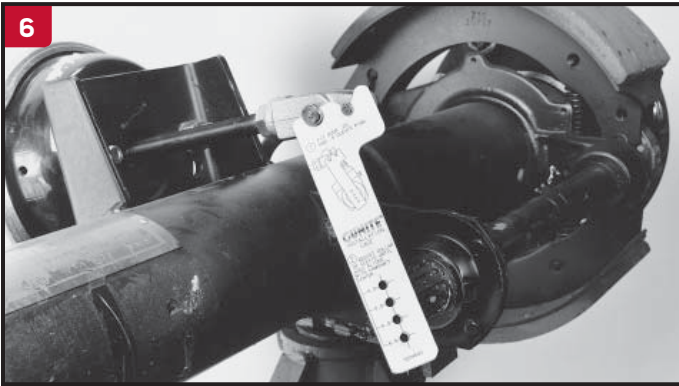

After threading the 1-1/4" collar nut onto the clevis housing, place the template over the large and small clevis pins as shown above.

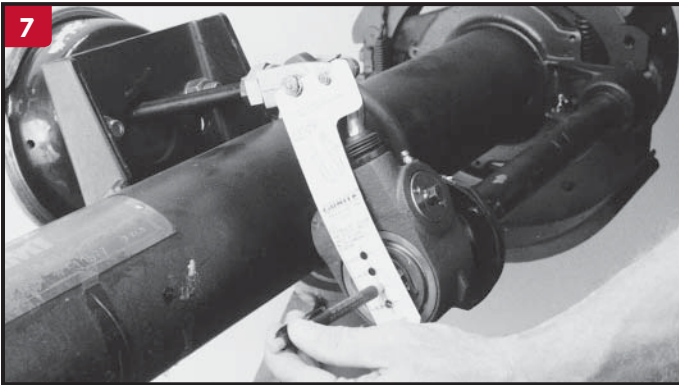

Align the Gunite automatic slack adjuster by adjusting the 3/4" hex nut on the push rod until the appropriate centering hole on the template aligns with the center hole on the camshaft. The template is provided with centering holes for 5, 5.5, 6, and 6.5 inch arm lengths. Refer to page 4 for proper gauge.

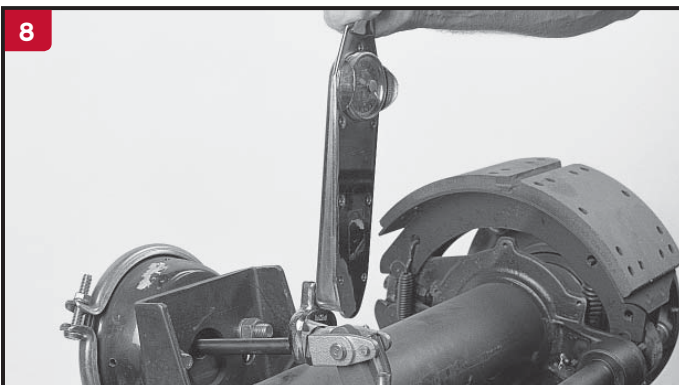

Using a torque wrench, tighten the 1-1/4" collar nut to the clevis using 40 to 50 ft. lbs. of torque.

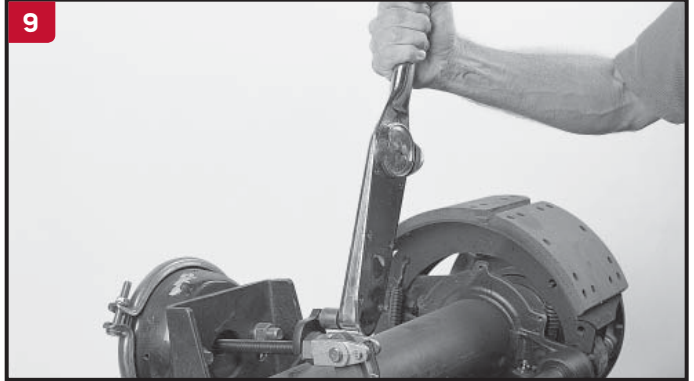

Once the 1-1/4" collar nut has been properly tightened to the clevis, tighten the 15/16" jam nut against the collar lock nut using 40 to 50 ft. lbs. of torque.

NOTE

Failure to tighten the jam nut will allow the air chamber push rod to rotate in the clevis and change the installed position of the Gunite automatic slack adjuster, preventing proper automatic slack adjuster function.

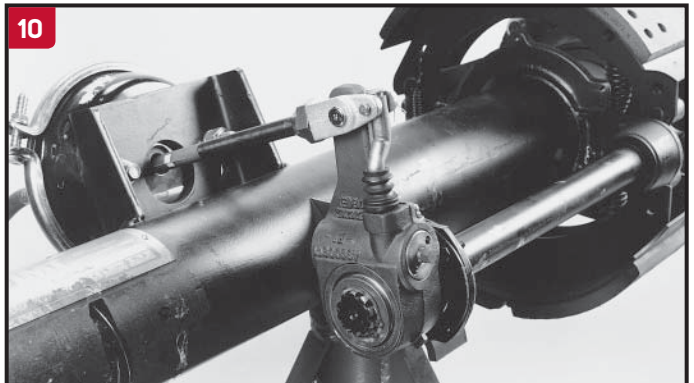

Fully apply the brakes and allow the chamber push rod to travel its maximum stroke. Clearance must exist between the Gunite automatic slack adjuster and all adjacent chassis components. Release the brakes.

After completing this step, refer to page 11 for Proper Brake Adjustment and Power Stroke Inspection.

ASA Installation Procedures by Clevis

Threaded Clevis ASA Installation Procedure

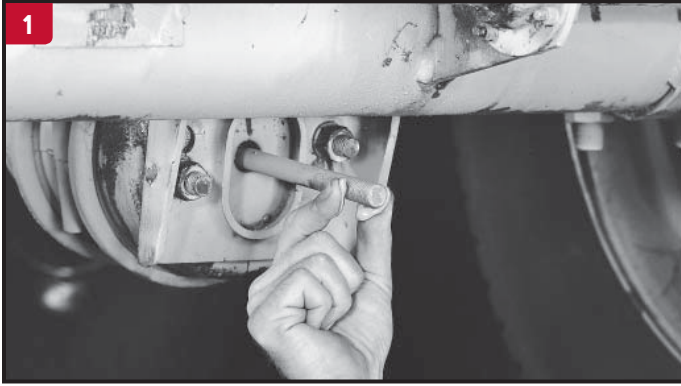

1 Apply anti-seize to the chamber push rod threads before installing the new clevis.



2 When installing a Gunitite automatic slack adjuster with a threaded clevis, install the new clevis on the push rod in the same location as the clevis which was removed. Do not tighten the jam nut at this time.



3 Once the clevis has been installed on the threaded push rod, install both the large and small clevis pins. Now position the installation template over both the large and small clevis pins. Refer to page 5 for proper gauge.

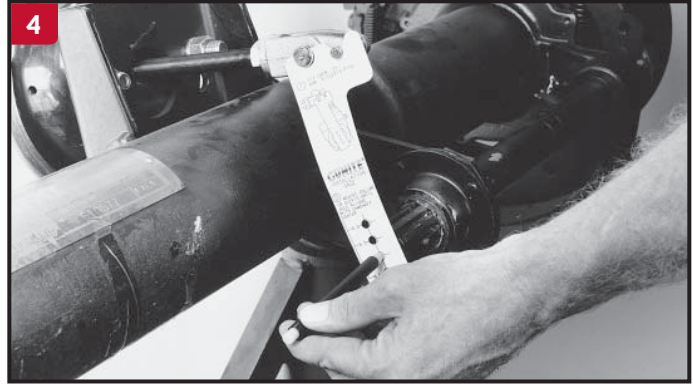

4 Align the clevis on the threaded push rod until the appropriate centering hole on the template aligns with the center hole on the camshaft. The template is provided with centering holes for 5, 5.5, 6, and 6.5 inch arm lengths.

Once the clevis has been properly adjusted, remove the template and the two clevis pins.

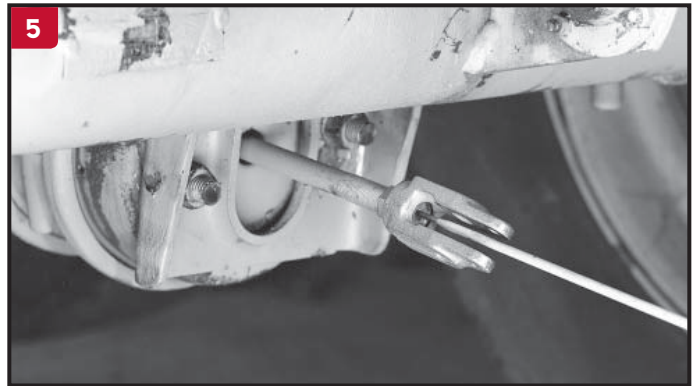

5 Inspect the clevis installation to make sure that the threaded push rod extends no more than 1/16" past the end of the opening of the clevis in the clevis housing. If the push rod extends more than 1/16" past the clevis housing, the clevis must be removed and the push rod cut to the proper length.

It is also important to make sure that the push rod is not too short for proper installation. To do this, check to make sure that the push rod is not more than 1/8" short of being flush with the clevis opening on a standard clevis (5/8" on an extended clevis). If the threaded push rod is more than 1/8" from being flush with the clevis opening on a standard clevis (5/8" on an extended clevis) it must be removed, a new push rod must be installed and cut to the proper length.

Follow instructions in this service manual for cutting a push rod to length.

NOTE

On axles equipped with spring brake chambers, be sure the chambers are fully caged before cutting the push rod. If the spring brakes are not fully caged, the push rod can be cut too short.

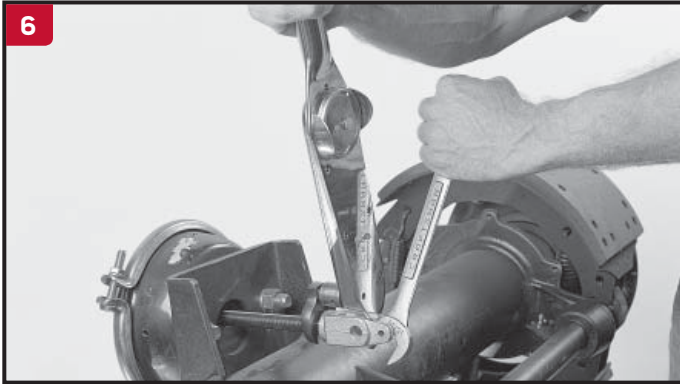

Tighten the jam nut against the clevis housing using 40 to 50 ft. lbs. of torque. If you do not tighten the jam nut now, it will allow the clevis to rotate freely and change the position of the slack resulting in an improper installation.

NOTE

Failure to tighten the jam nut will allow the air chamber push rod to rotate in the clevis and change the installed position of the slack, preventing proper automatic slack adjuster function.

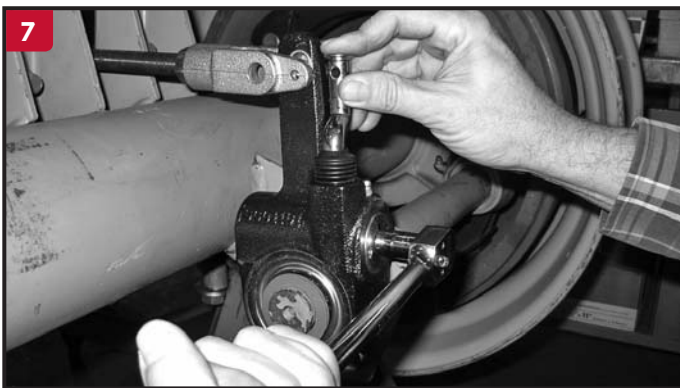

Apply anti-seize compound to the camshaft and install the automatic slack adjuster using the original mounting hardware. Use the hex extension to align the automatic slack adjuster with the clevis pin holes. Hold the link down while rotating the hex extension clockwise. Failure to do so can cause the link to disengage from the drive. Do not use an air impact wrench on the 7/16" hex. It can damage the clutch.



Once the clevis is properly aligned with the Gunite automatic slack adjuster, insert both the large and small clevis pins and secure with the cotter pins supplied.



Fully apply the brakes and allow the chamber push rod to travel its maximum stroke. Clearance must exist between the Gunite automatic slack adjuster and all adjacent chassis components. Release the brakes.

After completing this step, refer to page 11 for Proper Brake Adjustment and Power Stroke Inspection.

ASA Installation Procedures by Clevis

Welded Clevis ASA Installation Procedure

NOTE

These installation instructions are for air chambers with a welded on clevis. Welded on clevises have a 1.3" pin center distance.



Apply anti-seize compound to the camshaft and install the automatic slack adjuster using the original mounting hardware. Properly shim the automatic slack adjuster by placing one of the existing washers onto the camshaft. Next install the automatic slack adjuster onto the camshaft and place the second washer on the end of the camshaft, on the outside of the automatic slack adjuster. Re-attach the retaining clip.

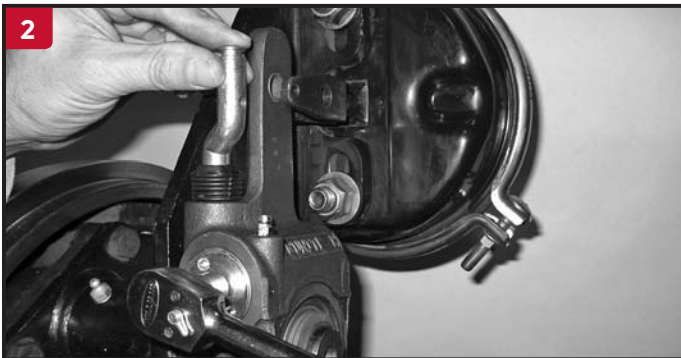

Using a 7/16" wrench or a socket, rotate the hex extension clockwise until the holes in the Gunitite automatic slack adjuster are properly aligned with the corresponding holes in the welded clevis. Hold the link down while rotating the hex extension clockwise. Failure to do so can cause the link to disengage from the drive. Do not use an air impact wrench on the 7/16" hex. It can damage the clutch.



Insert the large and small pins in the proper clevis holes.

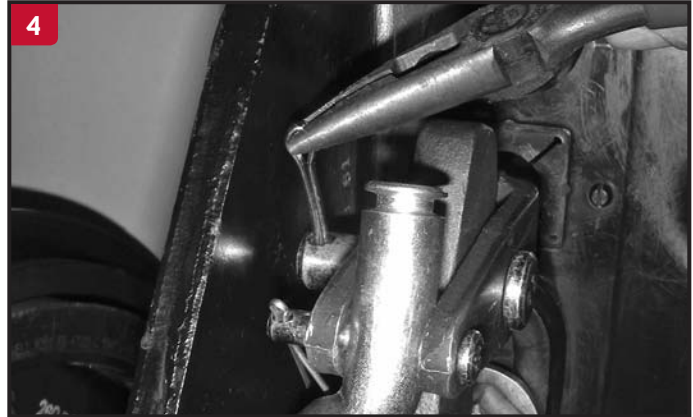

Insert the cotter pins into the large and small pin holes and secure the cotter pins.



Fully apply the brakes and allow the chamber push rod to travel its maximum stroke. Clearance must exist between the Gunitite automatic slack adjuster and all adjacent chassis components. Release the brakes.

NOTE

When installing the Gunitite 2000 slack adjuster with a welded on clevis air chamber, it is not necessary to use an installation gauge. The proper mounting angle has been designed into the product.

After completing this step, refer to page 11 for Proper Brake Adjustment and Power Stroke Inspection.

Brake Adjustment

Follow this Procedure to Properly Adjust the Brakes:

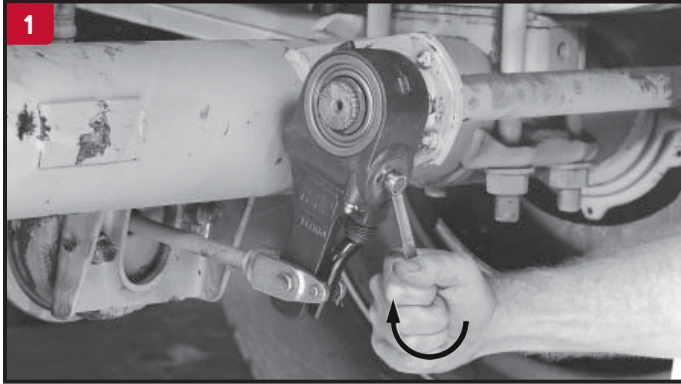

Using a 7/16" wrench or socket, rotate the hex extension **clockwise** until the brake linings make contact with the braking surface of the drum. Do not use an air impact wrench on the 7/16" hex. It can damage the clutch.

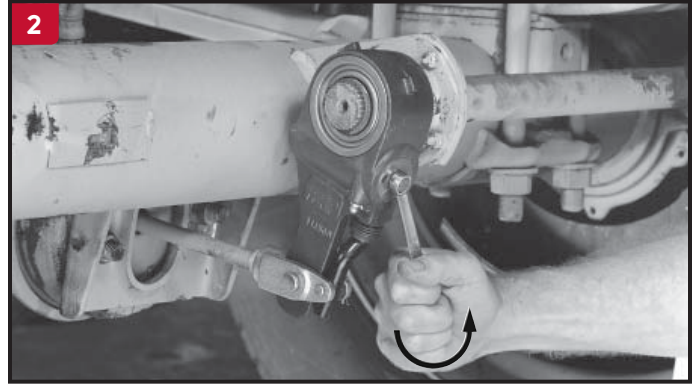

Using a 7/16" wrench or socket, back off the Gunite automatic slack adjuster by rotating the hex extension **counterclockwise** 1/2 turn. This will require 15 to 50 ft. lbs. of torque. When backing off the slack, a ratcheting sound will be heard.

WARNING

Gunite automatic slack adjusters should not be manually adjusted in an effort to correct excessive pushrod stroke. Excessive pushrod stroke indicates that a problem exists with the Gunite automatic slack adjuster, with the installation of the automatic slack adjuster, or with the related foundation brake components, which manual adjustment will not fix. Manual adjustment of Gunite automatic slack adjusters is a dangerous practice that could have serious consequences because it gives the operator a false sense of security about the effectiveness of brakes which are likely to go out of adjustment again soon.

Power Stroke Inspection

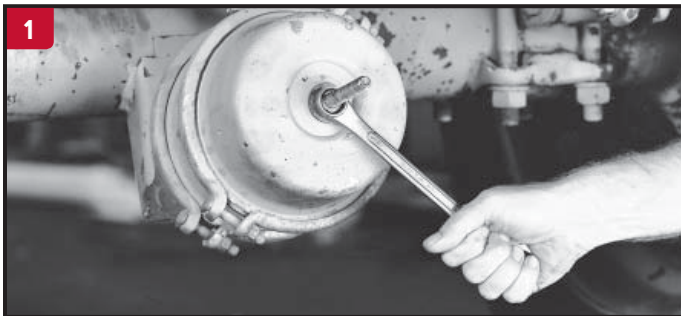

Block the wheels and uncage the spring brakes.

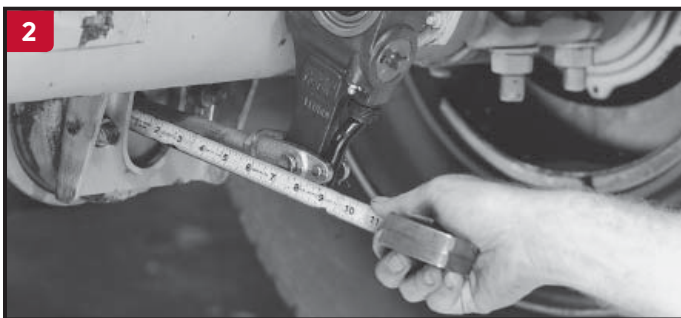

Using a ruler, measure the distance from the face of the air chamber to the center of the large pin in the clevis (A). (see Figure 3)

Make an 90-psi brake application and allow the air chamber to travel its maximum stroke. Measure the distance between the face of the air chamber and the center of the large clevis pin (B) (see Figure 3). The difference between the (A) measurement and the (B) measurement is the push rod stroke. Check the charts located on the next page for the proper maximum stroke after adjustment of the brakes.

"STANDARD" CLAMP TYPE BRAKE CHAMBER DATA

| Type | Outside Diameter | Rated Stroke | Maximum Legal Stroke Limit |
|------|------------------|--------------|----------------------------|
| 9 | 5-1/4 | 1.75 | 1-3/8 |
| 12 | 5-11/16 | 1.75 | 1-3/8 |
| 16 | 6-3/8 | 2.25 | 1-3/4 |
| 20 | 6-25/32 | 2.25 | 1-3/4 |
| 24 | 7-7/32 | 2.25 | 1-3/4 |
| 30 | 8-3/32 | 2.50 | 2 |
| 36* | 9 | 3.00 | 2-1/4 |

* Note: If type 36 chamber is used, slack length should be less than 6".

"LONG-STROKE" CLAMP TYPE BRAKE CHAMBER DATA

| Type | Outside Diameter | Rated Stroke | Maximum Legal Stroke Limit |
|------|------------------|--------------|----------------------------|
| 16 | 6-3/8 | 2.50 | 2 |
| 20 | 6-25/32 | 2.50 | 2 |
| 24 | 7-7/32 | 2.50 | 2 |
| 24* | 7-7/32 | 3.00 | 2-1/2 |
| 30* | 8-3/32 | 3.00 | 2-1/2 |

* Note: Identified by square air port bosses.

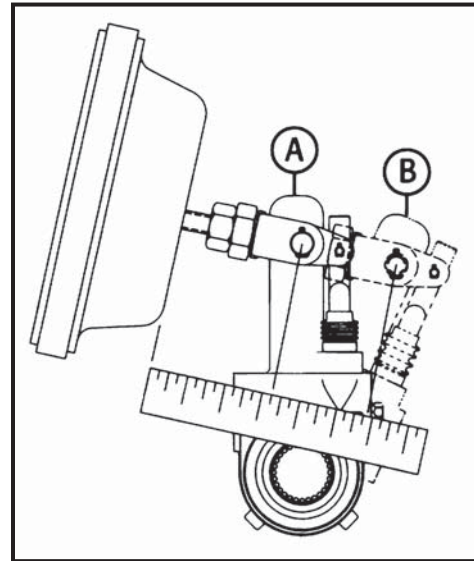

Figure 3 – Measuring Maximum Stroke

Recommended Maintenance

Every Three Months or 25,000 Miles

1. Check the condition of the foundation brakes, including drums, shoes and linings, cams, rollers, bushings, etc.
2. Check for structural damage of the housing, worn clevis, worn clevis bushings, and condition of the boot for cuts or tears. Replace if necessary.
3. After allowing the brake drum to cool to room temperature, check for correct chamber stroke following the procedure on page 10. Due to different operating conditions, chamber stroke tests may be necessary at earlier intervals. See charts above for the recommended stroke measurements.

WARNING

A Gunite automatic slack adjuster should not have to be manually adjusted except for initial installation and at the time of brake reline.

Every Six Months or 50,000 Miles Grease the Slack Adjuster

Gunite automatic slack adjusters are factory lubricated and extensively sealed to protect against dirt, water, salt, and other corrosive elements. Nevertheless, periodic lubrication is recommended.

1. A grease fitting is provided to allow lubrication during normal chassis servicing (see Figure 4). With a conventional grease gun, lubricate until grease appears on the camshaft.

NOTE

Lubrication should be performed using an NLGI 1 or 2 grade grease that has a working range of -40°F to 250°F. A grease containing Molybdenum Disulfide should not be used as it will likely have a negative impact on the function of key friction components and reduce the operational efficiency of the automatic slack adjuster.



Figure 4 – Lubrication Point

Recommended Maintenance

Service Practices: Points and Precautions

1. Replace the Gunitite automatic slack adjuster if it is not functioning properly, as described under Function Test on page 15.
2. Replace the entire unit if damage is evident on the slack housing or assembly.
3. The unit must be replaced if **less than 15 ft. lbs.** of torque exists when turning the hex extension counterclockwise. Refer to the test as described under Trouble Shooting on page 15.
4. Never operate the vehicle with small 1/4" pin missing from the clevis. The Gunitite automatic slack adjuster will not maintain proper brake adjustment with either pin missing (see below).
5. Never attempt to disassemble a Gunitite automatic slack adjuster. Factory setting cannot be duplicated in the field. Instead, replace the entire unit.

Bushing Replacement



Insert clevis pin into a new bushing. Support arm of Gunitite automatic slack adjuster and insert clevis pin with new bushing into old bushing.

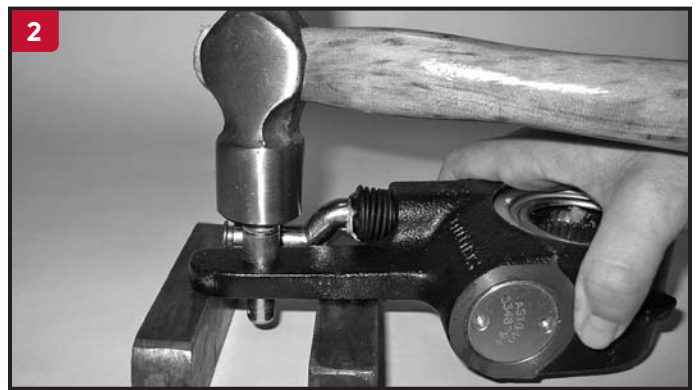

Using a hammer, drive the new bushing into the arm of the automatic slack adjuster while driving out the old bushing. Make sure the new bushing is flush with the sides of the arm.

Cutting Push Rods

This Procedure is for Collar Lock and Threaded Clevis Applications Only

1. Install the brake chamber in the proper mounting holes of the chamber bracket for the Gunitite automatic slack adjuster length required.
2. If the axle is equipped with spring brake chamber, manually cage the spring brakes following the manufacturer's recommended procedures. **The chamber must be in the fully released position.**
3. Using a square, mark the universal push rod at the 90 degree position when the square edge is centered in the end of the S-Cam (see Figure 5). Make sure the push rod is centered in the chamber and not cocked before marking the push rod.
4. From the 90 degree mark, measure back toward the air chamber the proper "X" distance from the following chart. Mark the push rod at the "X" dimension. Cut the push rod at this mark (see Figure 6). The clevis is now ready to install on the push rod.

| Slack Adjuster Arm Length | "X" Dimension | |
|---------------------------|------------------------|--------------------|
| | Gunite Standard Clevis | Gunite 2000 Clevis |
| 5" - 5-1/2" | 2-1/4" | 2-1/2" |
| 6" - 6-1/2" | 2-1/2" | 2-3/4" |

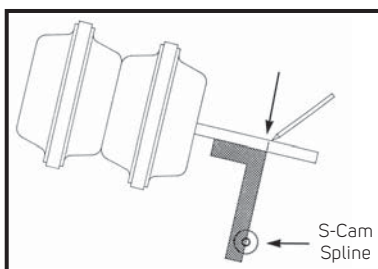

Figure 5 – Marking the Push Rod

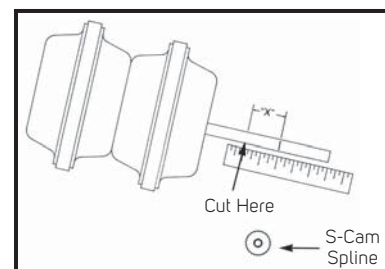
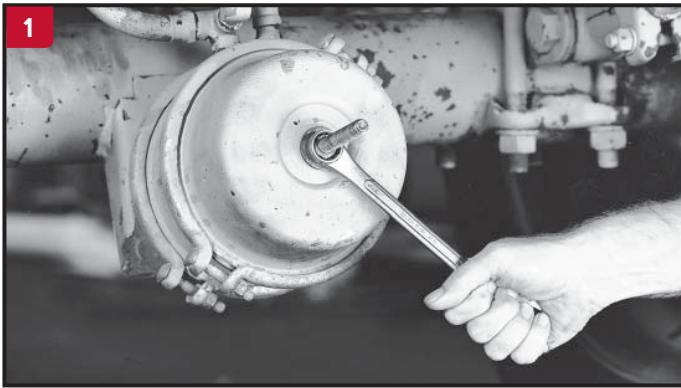

Figure 6 – Cutting the Push Rod

Brake Lining and/or Drum Replacement

Special attention must be given to following proper maintenance procedures when changing linings and/or drums on a vehicle equipped with Gunitite automatic slack adjusters. Following these procedures will ensure that the automatic slack adjuster is functioning correctly before returning the vehicle to service.

Block the vehicle's wheels.



If the vehicle is equipped with spring brake chambers, manually cage the spring brakes following the manufacturer's recommended procedures.

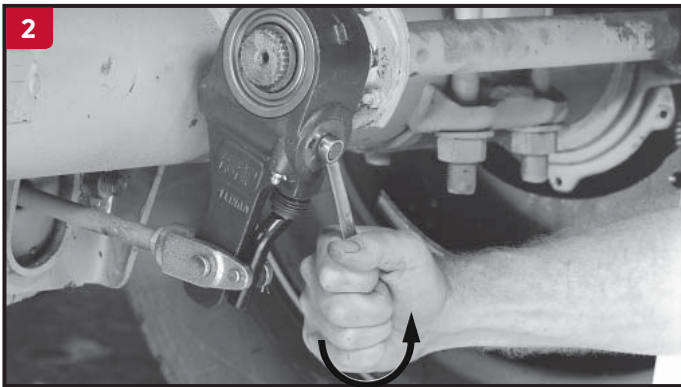

Using a 7/16" wrench or socket, rotate the hex extension counterclockwise. You should have at least 15 ft. lbs. resistance and a ratcheting sound will be heard as the hex extension is rotated. Do not use an air impact wrench on the 7/16" hex. It can damage the clutch.

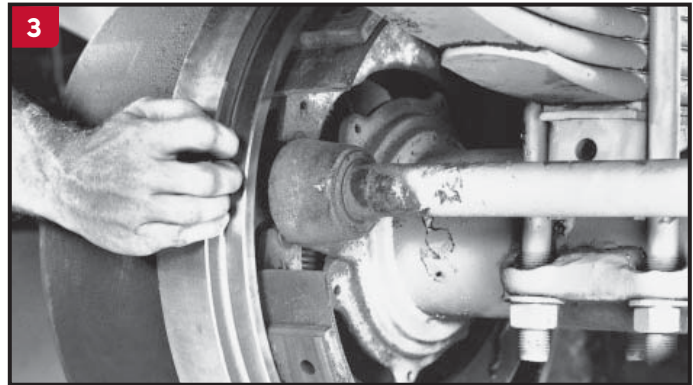

Only back off the adjusting hex enough to allow the drum to clear the lining. Remove the brake drum.

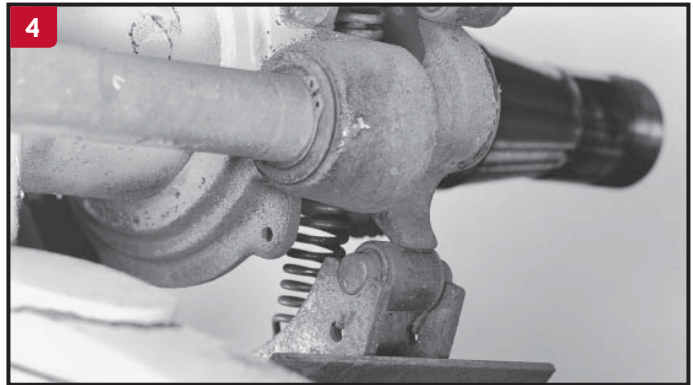

After the brake drum has been removed; rotate the hex extension clockwise until the cam turns over. This will allow the brake rollers to be in the release position.

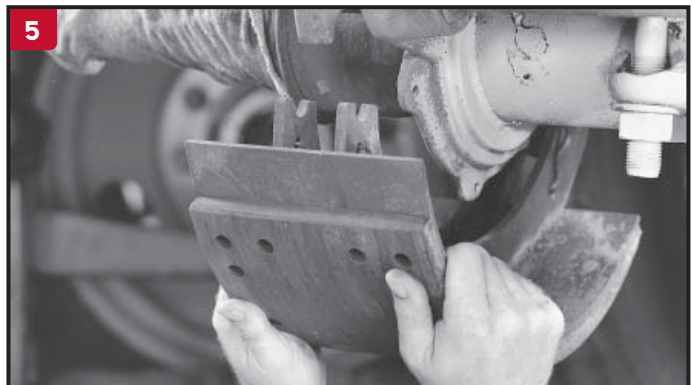

Proceed with the lining change and/or brake drum replacement.

After completing this step, refer to page 11 for proper brake adjustment, uncage the spring brakes, and refer to page 11 for power stroke inspection.

Troubleshooting

1. Gunite automatic slack adjusters should not have to be manually adjusted except for initial installation and at the time of brake reline. If the power stroke, with an 90-psi brake application is less than the **Maximum Legal Stroke Limit** shown in the chart on page 11, the Gunite automatic slack adjuster is functioning properly.
2. If the chamber stroke exceeds the **Maximum Legal Stroke Limit**, measure the **free stroke**.
3. Free stroke is the amount of movement of the slack adjuster arm required to move the brake shoes against the drum. With the brakes released, measure from the face of the air chamber to the center of the large clevis pin (see Figure 7).

Apply pressure using a lever to activate the Gunite automatic slack adjuster until the brake shoes make contact with the brake drum surface. The difference between the released and the applied measurements is the free stroke. The **free stroke** should be 3/8" to 5/8".

If the **free stroke** is less than 3/8", a dragging brake can occur. If this situation occurs repeat the manual adjustment by repeating steps 1 through 3 under Brake Adjustment.

If the **free stroke** is greater than the recommended distance of 5/8", a function test of the Gunite automatic slack adjuster should be performed.

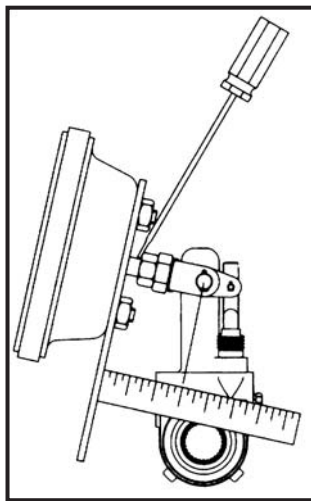

Figure 7 – Free Stroke

4. To perform a **function test**, place a 7/16" box wrench on the hex extension and rotate it 3/4 of a turn counterclockwise. A ratcheting sound will be heard. Mark the 7/16" hex extension with chalk and apply the brakes several times and watch for the hex to rotate clockwise. The hex extension must rotate clockwise. The adjustment is intentionally made in small increments so it will take several cycles to bring the adjuster within the **Maximum Legal Stroke Limit** in the chart on page 12.

If the **power stroke** is greater than the Maximum Legal Stroke Limit, the **free stroke** is greater than 5/8" and the function test shows that the adjusting mechanism is working check the clevis pins, clevis pin holes, and arm bushing for wear. Replacing clevises, pins, and bushings that show wear may bring the brake within the legal stroke limit.

5. Check the **clockwise and counterclockwise torque** by attaching a torque wrench to the hex extension and turning in the clockwise and counterclockwise directions and record the measurement. The clockwise torque specification is 10 ft. lbs. maximum. The counterclockwise torque specification is 15 to 50 ft. lbs. If these torque specifications are violated the Gunite automatic slack adjuster must be replaced.
6. If the Gunite automatic slack adjuster passes the **free stroke, function test, clockwise and counterclockwise torque tests** and the brake does not meet the **Maximum Legal Stroke Limit** check the foundation brake. Check for worn cam bushings, pins, rollers, broken springs, broken drums, sprung linings, worn quick connect clevises, clevis pins, and clevis bushings. Repair as necessary and repeat the **function test** to see if the Gunite automatic slack adjuster meets the **Maximum Legal Stroke Limit**.
7. Pins seizing are a result of corrosive environments. If pins seizing are a problem, they should be replaced with stainless steel pins.

WARNING

Gunite automatic slack adjusters should not be manually adjusted in an effort to correct excessive pushrod stroke. Excessive pushrod stroke indicates that a problem exists with the automatic slack adjuster, with the installation of the automatic slack adjuster, or with the related foundation brake components, which manual adjustment will not fix. Manual adjustment of Gunite automatic slack adjusters is a dangerous practice that could have serious consequences because it gives the operator a false sense of security about the effectiveness of brakes which are likely to go out of adjustment again soon.

If you need additional service manuals or installation gauges, contact Gunite at the address listed on the back of this manual.

ACCURIDE WHEEL END SOLUTIONS (AWES) LIMITED WARRANTY TO FILE A WARRANTY CLAIM, CALL 1-800-869-2275 ext 1

Accuride Wheel End Solutions (AWES) warrants to the original purchaser that its products are free from defects in material and workmanship. The limited warranty time-frame (reference table below) is based on the date of product manufacture and shall be void if the product is altered, modified, misapplied, misused, neglected, repaired or not maintained in accordance with the instructions printed in the product-specific Accuride Wheel End Solutions' Safety & Service Manuals⁽²⁾.

GENERAL PRODUCT OVERVIEW

| Product Type | 5 years/ 60 months | 5 years/ 500,000 miles ⁽¹⁾ | 1 year/ 12 months | 3 years/ 350,000 miles ⁽¹⁾ | 3 years/ 300,000 miles ⁽¹⁾ | 2 years/ 200,000 miles ⁽¹⁾ | Limited Warranty |
|---|---|---|--|---|---|---|-------------------------------------|
| Accuride Aluminum Wheels⁽²⁾ | Industry Standard Aluminum wheels Duplex® Aluminum Wheels ACCU-SHIELD® Wheels ACCU-ARMOR™ Wheels | | | | | ACCU-FLANGE™ Wheels | |
| Accuride Steel Wheels⁽²⁾ | Extra Service Wheels™ (ESW) Styled Steel Wheels Tubeless Wheels and Demountable Rims | | Duplex® Steel Disc Wheels Duplex® Demountable Rims Tube-Type Wheels & Demountable Rims Light Truck Wheels Steel Bolt-Together Specialty Wheels | | | | |
| Gunite Slack Adjusters⁽²⁾ | | Over-The Road/Line Operated Trucks and Trailers | | | School Bus/City Delivery Vehicles | Severe Service: Garbage/Refuse Trucks, Fire Trucks, Logging, etc. | |
| Gunite Hubs⁽²⁾ | | TRU-SET® Trailer | | TRU-SET® Front/Steer TRU-SET® Rear/Drive | | | Industry Standard Hubs |
| Gunite Brake Drums⁽²⁾ | | | | | | | Industry Standard Brake Drums |
| Gunite Disc Brake Rotors⁽²⁾ | | | | | | | Industry Standard Disc Brake Rotors |
| Gunite Spoke Wheels⁽²⁾ | | | | | | | Industry Standard Spoke Wheels |

(1) Time or miles, whichever occurs first

(2) Refer to appropriate Accuride Wheel End Solutions guide for additional limited warranty condition details: Accuride Rim/Wheel Safety & Service Manual, Gunite Heavy-Duty Brake Drums, Gunite Automatic Slack Adjuster Service Manual, Gunite Disc Brake Rotors Maintenance Manual, and Gunite Disc Wheel Hubs, High-Performance Hubs, and Spoke Wheels Maintenance & Installation Manual

ACCURIDE WHEEL END SOLUTIONS (AWES) LIMITED WARRANTY TO FILE A WARRANTY CLAIM, CALL 1-800-869-2275 ext 1

ADDITIONAL PRODUCT SPECIFIC LIMITED WARRANTY CRITERIA

Wheels: The above warranty shall be void if the product is used with improper tire sizes, inflation pressures, or exceeded load ratings. The above warranty shall be void if the product is not properly maintained in accordance with the Accuride Rim/Wheel Safety & Service Manual. The above warranty also does not cover defects resulting from corrosion (except as noted above), other non-Accuride components, accident, excessive speed or other abnormal or severe operating conditions.

ACCU-ARMOR™ and ACCU-SHIELD®: AWES does not cover the following conditions: (i) Any damage in the areas of the mounting surfaces, such as the area under the mounting nuts, the area in contact with hubs or drums and the area in contact with other wheels in dual position, (ii) Any damage due to cleaning, including damage from the use of abrasives, abrasive brushes, steel wool, scouring pads or strong chemicals, and (iii) Any damage to the wheel finish due to removal, misuse, or chipping, whether by contact with road obstacles such as stones, gravel, curbs, barriers, signs, or otherwise. ACCU-SHIELD® products are not covered for corrosion. AWES recommends cleaning wheels with mild soap and water.

ACCU-FLANGE™: The Accu-Flange treatment warranty covers original purchasers against sharp edges on the rim flange for two (2) years from the date of manufacture. This warranty does not cover the following conditions: (i) Any damage due to cleaning, including damage from the use of abrasives, abrasive brushes, steel wool, scouring pads, strong chemicals or corrosives, and (ii) Any damage due to removal, misuse, or chipping, whether by contact with road obstacles such as stones, gravel, curbs, barriers, signs, tire changing equipment, or otherwise. For Accu-Flange / Accu-Shield or Accu-Flange / Accu-Armor wheels, AWES recommends cleaning with mild detergent and water only. For Accu-Flange only wheels, AWES recommends cleaning with mild detergent and water and then apply a wheel polish or carnauba wax with 100% cotton cloth.

Standard Brake Drums, Spoke Wheels, Disc Wheel Hubs, Automatic Slack Adjusters, and Hardware: The above warranty shall be void if (i) any goods have exceeded AWES' acceptable wear limits or have been subjected to accidents or abnormal conditions of use, temperature, moisture, dirt or corrosive matter, or (ii) the product fails as the result of another manufacturer's product. The TRU-SET® disc wheel hub requires the use of a seller-approved hubcap and lubricant.

REMEDIES AND LIMITATIONS OF REMEDIES

In the event of any material breach of the above limited warranties, AWES agrees to repair or replace, at its sole option, without charge any and all of its warrantable product that fail during normal use and service due to defects in material and/or workmanship, all subject to the original purchaser providing written notice of the alleged breach within 30 days of failure. Time is of the essence herein, and original purchaser's failure to provide written notice to AWES within the required time of any alleged breach of the foregoing warranty will release and discharge AWES from any obligation or liability for that breach of warranty. In no event will AWES be liable for any other costs associated with the replacement or repair of product covered under this warranty, including labor, installation or other costs incurred by customer.

The remedies set forth herein shall be the sole and exclusive remedies available to the original purchaser so that AWES repair or replacement is a fulfillment of all AWES obligations. AWES SHALL NOT BE LIABLE FOR ANY CONSEQUENTIAL OR INCIDENTAL DAMAGES OF ANY KIND. FURTHER, UNDER NO CIRCUMSTANCE SHALL AWES BE LIABLE FOR DAMAGES BEYOND THE PRICE OF THE GOODS PURCHASED BY THE ORIGINAL PURCHASER, WHETHER IN CONTRACT, IN TORT OR UNDER ANY WARRANTY OR OTHER USE.

AWES reserves the right to request product return as a condition of reimbursement. Return expense may be paid by AWES or may be reimbursed to the original purchaser if product is found to be warrantable. No goods are to be returned to AWES without a Returned Goods Authorization (RGA). If AWES determines that any of the returned goods are non-warrantable, AWES reserves the right to charge the original purchaser for the recovery of all transportation costs and expenses incurred in examining, processing and handling such goods. Any controversy or claim that customer may wish to bring that is arising out of or related to this limited warranty or breach hereof must be commenced in writing within 30 days of notification of warrantable status.

Any product deemed non-warrantable is the property of the original purchaser and can be returned to the original purchaser upon its request and at its sole cost and expense. Should the non-warrantable item(s) not be reclaimed, AWES will disposition the product no sooner than 30 days after original purchaser notification has been made.

For all warranty related questions, please contact your AWES warranty administrator at 1-800-869-2275 Option 1 or submit questions or claims to warrantyadmin@accuridecorp.com. A completed warranty claim form can also be faxed to 1-815-964-0775.

THE ABOVE WARRANTY IS THE SOLE AND EXCLUSIVE WARRANTY GIVEN BY AWES AND IS IN LIEU OF ALL OTHER WARRANTIES EXPRESSED, STATUTORY OR IMPLIED, INCLUDING WARRANTIES OF MERCHANTABILITY AND FITNESS FOR A PARTICULAR PURPOSE, ALL OF WHICH ARE EXPRESSLY DISCLAIMED BY AWES. IN NO EVENT SHALL THIS WARRANTY BE DEEMED TO COVER INCIDENTAL, SPECIAL, INDIRECT OR CONSEQUENTIAL DAMAGES OF ANY KIND.

NOTES



Your only single source for industry-leading wheel end solutions.
STEEL & ALUMINUM WHEELS | DRUMS | HUBS | ROTORS | SLACK ADJUSTERS

(800) 677-3786 / (815) 964-3301 | accuridewheelendsolutions.com
Gunite | 302 Peoples Avenue | Rockford, IL 61104-7092